

HiPerFAST™ IGBT with Diode

C2-Class High Speed IGBTs

IXGH 30N60C2D1
IXGT 30N60C2D1

V_{CES} = 600 V
 I_{C25} = 70 A
 $V_{CE(sat)}$ = 2.7 V
 $t_{fi typ}$ = 32 ns

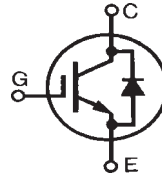

Symbol	Test Conditions	Maximum Ratings	
V_{CES}	$T_J = 25^\circ\text{C}$ to 150°C	600	V
V_{CGR}	$T_J = 25^\circ\text{C}$ to 150°C ; $R_{GE} = 1\ \text{M}\Omega$	600	V
V_{GES}	Continuous	± 20	V
V_{GEM}	Transient	± 30	V
I_{C25}	$T_C = 25^\circ\text{C}$ (limited by leads)	70	A
I_{C110}	$T_C = 110^\circ\text{C}$	30	A
I_{CM}	$T_C = 25^\circ\text{C}$, 1 ms	150	A
SSOA (RBSOA)	$V_{GE} = 15\ \text{V}$, $T_{VJ} = 125^\circ\text{C}$, $R_G = 10\ \Omega$ Clamped inductive load @ $\leq 600\ \text{V}$	$I_{CM} = 60$	A
P_C	$T_C = 25^\circ\text{C}$	190	W
T_J		-55 ... +150	$^\circ\text{C}$
T_{JM}		150	$^\circ\text{C}$
T_{stg}		-55 ... +150	$^\circ\text{C}$
Maximum lead temperature for soldering 1.6 mm (0.062 in.) from case for 10 s		300	$^\circ\text{C}$
Plastic body for 10s		250	$^\circ\text{C}$
M_d	Mounting torque (TO-247)	1.13/10Nm/lb.in.	
Weight	TO-247	6	g
	TO-268	4	g

TO-247 AD (IXGH)

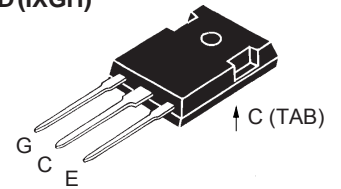

TO-268 (IXGT)

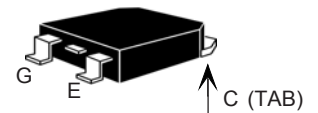

G = Gate, C = Collector,
E = Emitter, TAB = Collector

Features

- Very high frequency IGBT
- Square RBSOA
- High current handling capability
- MOS Gate turn-on
- drive simplicity

Applications

- PFC circuits
- Uninterruptible power supplies (UPS)
- Switched-mode and resonant-mode power supplies
- AC motor speed control
- DC servo and robot drives
- DC choppers

Advantages

- High power density
- Very fast switching speed for high frequency applications
- High power surface mountable package

Symbol	Test Conditions	Characteristic Values ($T_J = 25^\circ\text{C}$, unless otherwise specified)		
		min.	typ.	max.
$V_{GE(th)}$	$I_C = 250\ \mu\text{A}$, $V_{CE} = V_{GE}$	2.5		5.0 V
I_{CES}	$V_{CE} = V_{CES}$ $V_{GE} = 0\ \text{V}$			$T_J = 25^\circ\text{C}$: 200 μA $T_J = 125^\circ\text{C}$: 3 mA
I_{GES}	$V_{CE} = 0\ \text{V}$, $V_{GE} = \pm 20\ \text{V}$			$\pm 100\ \text{nA}$
$V_{CE(sat)}$	$I_C = 24\ \text{A}$, $V_{GE} = 15\ \text{V}$		1.8	$T_J = 25^\circ\text{C}$: 2.7 V $T_J = 125^\circ\text{C}$: V

Symbol	Test Conditions	Characteristic Values ($T_J = 25^\circ\text{C}$, unless otherwise specified)			
		min.	typ.	max.	
g_{fs}	$I_C = 24\text{ A}; V_{CE} = 10\text{ V}$, Pulse test, $t \leq 300\ \mu\text{s}$, duty cycle $\leq 2\%$	18	28	S	
C_{ies} C_{oes} C_{res}	$V_{CE} = 25\text{ V}, V_{GE} = 0\text{ V}, f = 1\text{ MHz}$		1430	pF	
			140	pF	
			40	pF	
Q_g Q_{ge} Q_{gc}	$I_C = 24\text{ A}, V_{GE} = 15\text{ V}, V_{CE} = 300\text{ V}$		70	nC	
			10	nC	
			23	nC	
$t_{d(on)}$ t_{ri} $t_{d(off)}$ t_{fi} E_{off}	Inductive load, $T_J = 25^\circ\text{C}$ $I_C = 24\text{ A}, V_{GE} = 15\text{ V}$ $V_{CE} = 400\text{ V}, R_G = 5\ \Omega$		13	ns	
			15	ns	
			70	140	ns
			60	ns	
			0.19	0.30	mJ
$t_{d(on)}$ t_{ri} E_{on} $t_{d(off)}$ t_{fi} E_{off}	Inductive load, $T_J = 125^\circ\text{C}$ $I_C = 24\text{ A}, V_{GE} = 15\text{ V}$ $V_{CE} = 400\text{ V}, R_G = 5\ \Omega$		13	ns	
			17	ns	
			0.22	mJ	
			120	ns	
			130	ns	
			0.59	mJ	
R_{thJC} R_{thCK}	(TO-247)			0.65 KW	
		0.25		KW	

Reverse Diode (FRED)

Symbol	Test Conditions	Characteristic Values ($T_J = 25^\circ\text{C}$, unless otherwise specified)		
		min.	typ.	max.
V_F	$I_F = 30\text{ A}, V_{GE} = 0\text{ V}$, Pulse test $t \leq 300\ \mu\text{s}$, duty cycle $d \leq 2\%$	$T_J = 150^\circ\text{C}$		1.6 2.5 V V
I_{RM} t_{rr}	$I_F = 30\text{ A}, V_{GE} = 0\text{ V}, -di_F/dt = 100\text{ A}/\mu\text{s}, T_J = 100^\circ\text{C}$ $V_R = 100\text{ V}, T_J = 100^\circ\text{C}$ $I_F = 1\text{ A}; -di_F/dt = 100\text{ A}/\mu\text{s}; V_R = 30\text{ V}$		100	4 ns ns A
			25	ns
R_{thJC}				0.9 KW

TO-247 AD Outline

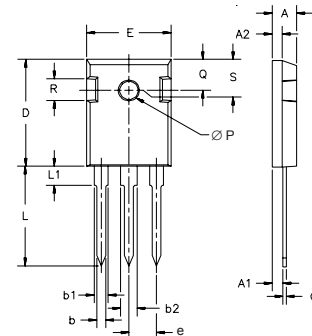

Dim.	Millimeter		Inches	
	Min.	Max.	Min.	Max.
A	4.7	5.3	.185	.209
A ₁	2.2	2.54	.087	.102
A ₂	2.2	2.6	.059	.098
b	1.0	1.4	.040	.055
b ₁	1.65	2.13	.065	.084
b ₂	2.87	3.12	.113	.123
C	.4	.8	.016	.031
D	20.80	21.46	.819	.845
E	15.75	16.26	.610	.640
e	5.20	5.72	0.205	0.225
L	19.81	20.32	.780	.800
L1		4.50		.177
∅P	3.55	3.65	.140	.144
Q	5.89	6.40	0.232	0.252
R	4.32	5.49	.170	.216
S	6.15	BSC	242	BSC

TO-268 Outline

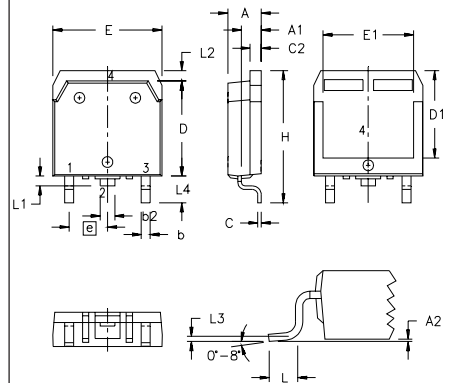

SYM	INCHES		MILLIMETERS	
	MIN	MAX	MIN	MAX
A	.193	.201	4.90	5.10
A1	.106	.114	2.70	2.90
A2	.001	.010	0.02	0.25
b	.045	.057	1.15	1.45
b2	.075	.083	1.90	2.10
C	.016	.026	0.40	0.65
C2	.057	.063	1.45	1.60
D	.543	.551	13.80	14.00
D1	.488	.500	12.40	12.70
E	.624	.632	15.85	16.05
E1	.524	.535	13.30	13.60
e	.215 BSC		5.45 BSC	
H	.736	.752	18.70	19.10
L	.094	.106	2.40	2.70
L1	.047	.055	1.20	1.40
L2	.039	.045	1.00	1.15
L3	.010 BSC		0.25 BSC	
L4	.150	.161	3.80	4.10

IXYS reserves the right to change limits, test conditions, and dimensions.

IXYS MOSFETs and IGBTs are covered by one or more of the following U.S. patents:	4,835,592	4,931,844	5,049,961	5,237,481	6,162,665	6,404,065B1	6,683,344	6,727,585
	4,850,072	5,017,508	5,063,307	5,381,025	6,259,123B1	6,534,343	6,710,405B2	6,759,692
	4,881,106	5,034,796	5,187,117	5,486,715	6,306,728 B1	6,583,505	6,710,463	6771478B2

Fig. 1. Output Characteristics
@ 25 Deg. C

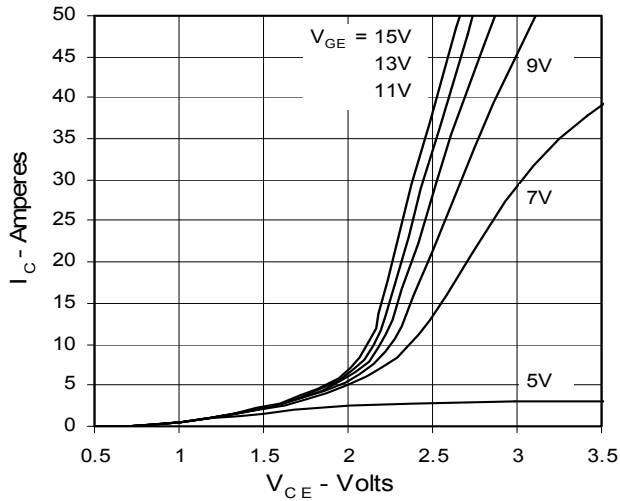

Fig. 2. Extended Output Characteristics
@ 25 deg. C

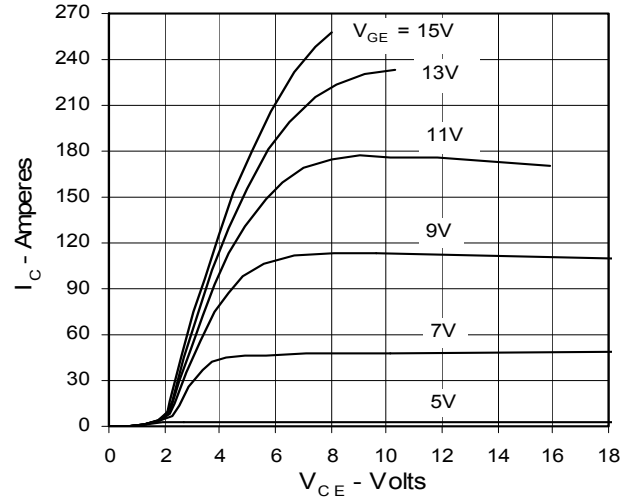

Fig. 3. Output Characteristics
@ 125 Deg. C

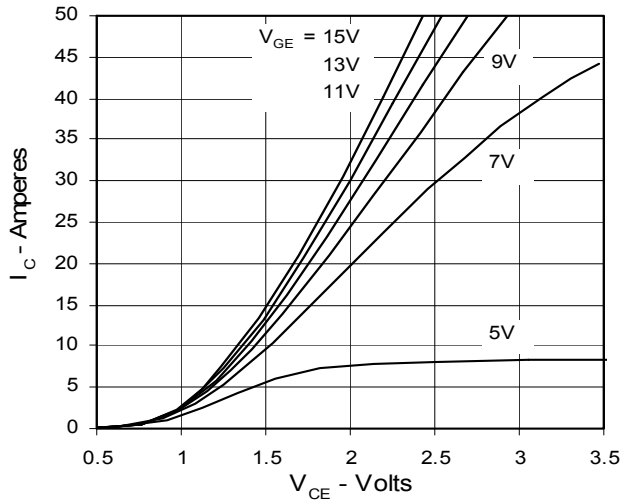

Fig. 4. Dependence of $V_{CE(sat)}$ on Temperature

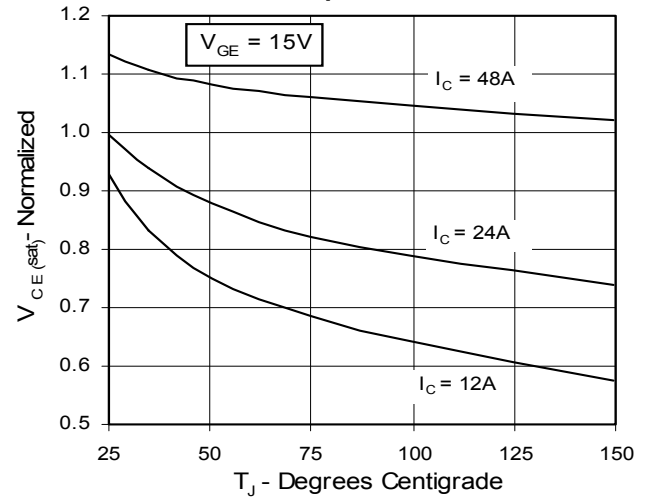

Fig. 5. Collector-to-Emitter Voltage vs. Gate-to-Emitter voltage

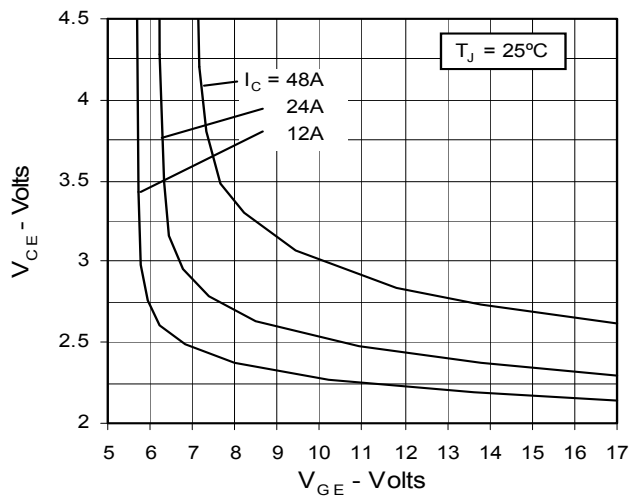

Fig. 6. Input Admittance

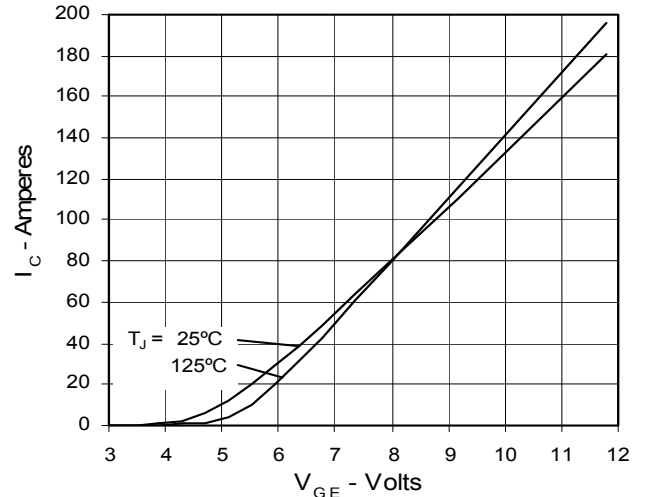

Fig. 7. Transconductance

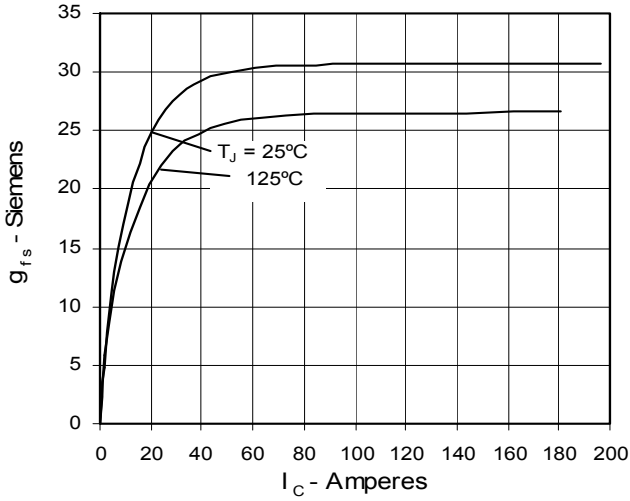

Fig. 8. Dependence of Turn-Off Energy on R_G

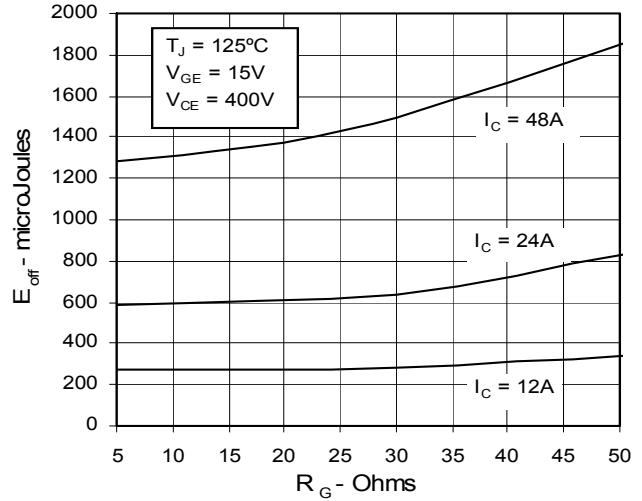

Fig. 9. Dependence of Turn-Off Energy on I_C

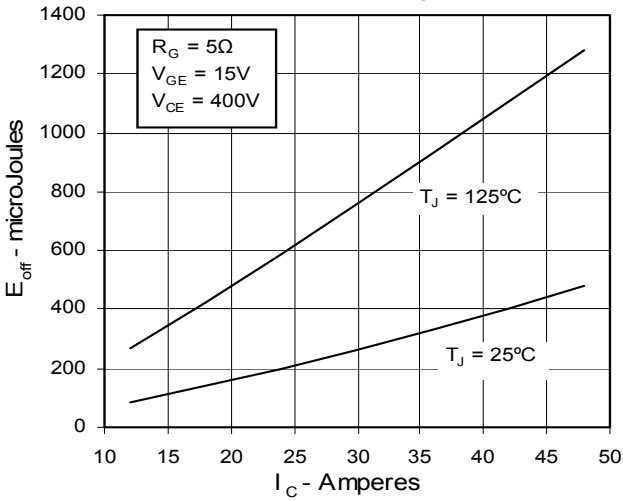

Fig. 10. Dependence of Turn-Off Energy on Temperature

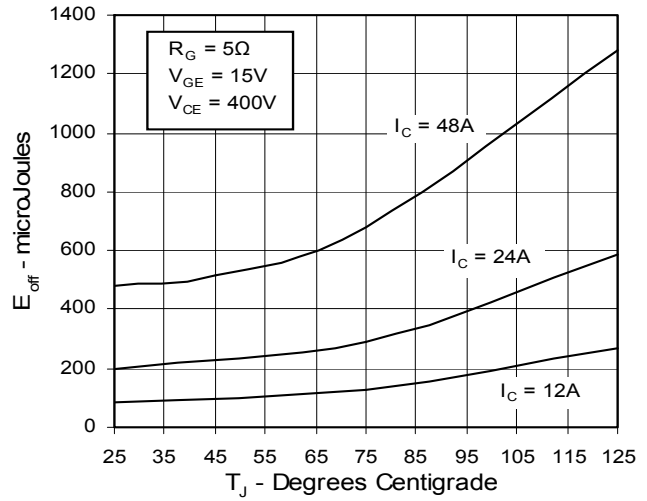

Fig. 11. Dependence of Turn-Off Switching Time on R_G

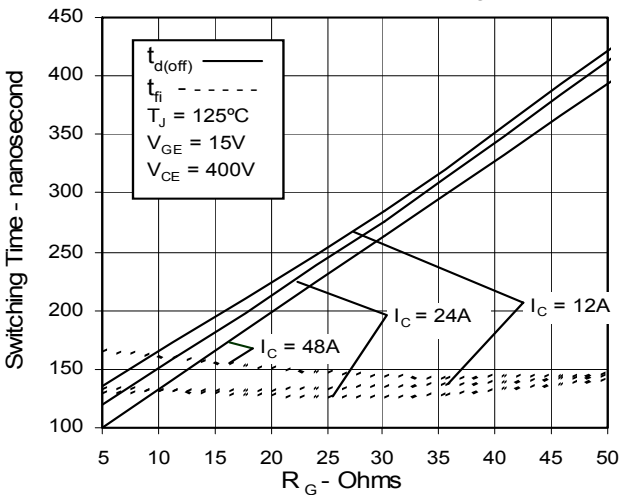

Fig. 12. Dependence of Turn-Off Switching Time on I_C

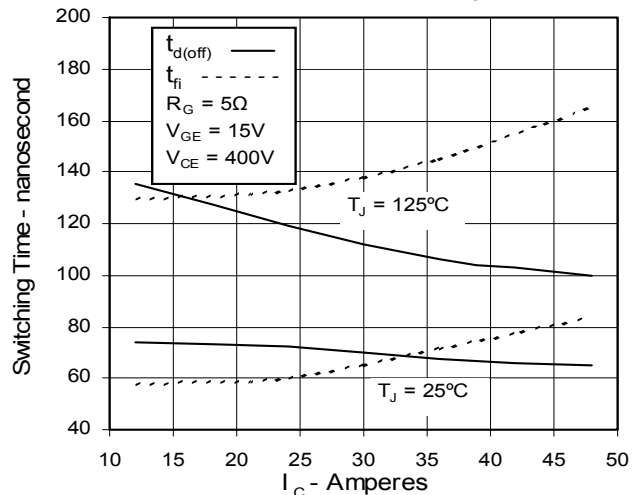

Fig. 13. Dependence of Turn-Off Switching Time on Temperature

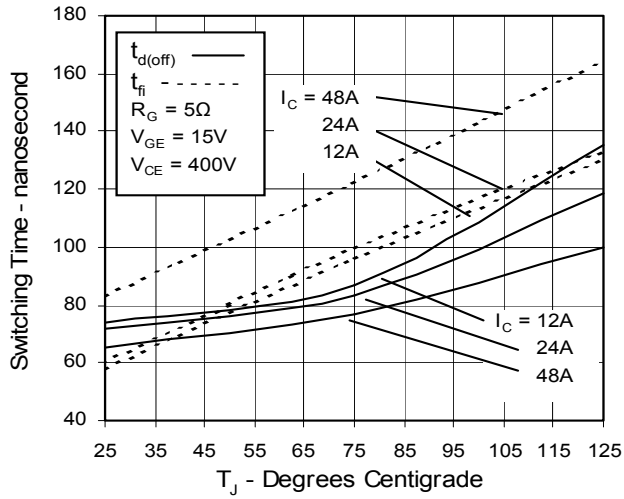

Fig. 14. Gate Charge

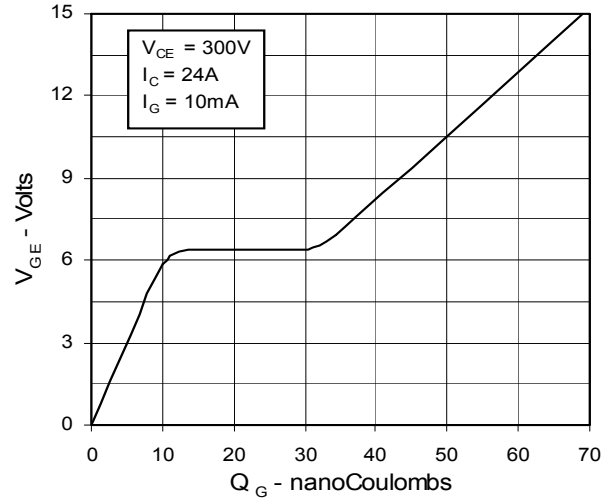

Fig. 15. Capacitance

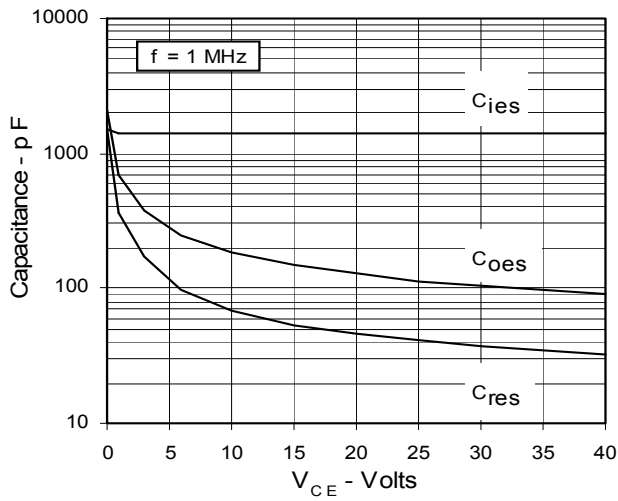
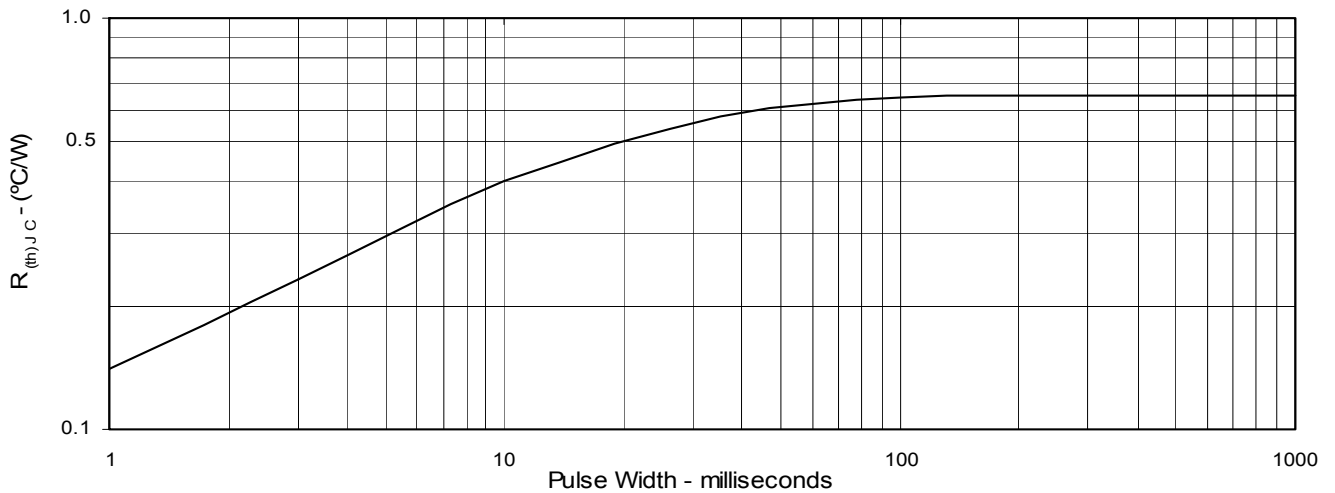

Fig. 16. Maximum Transient Thermal Resistance



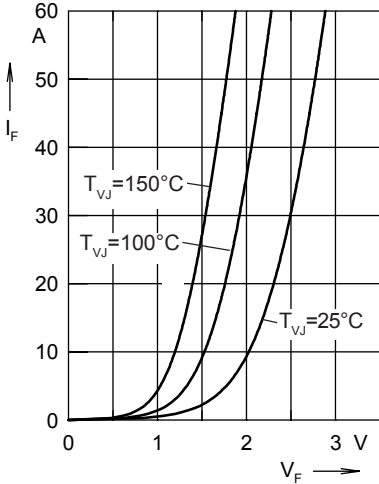

Fig. 17. Forward current I_F versus V_F

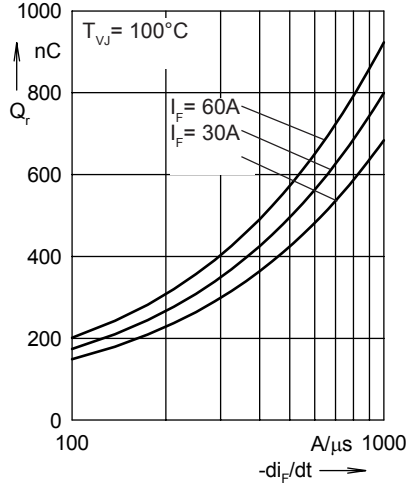

Fig. 18. Reverse recovery charge

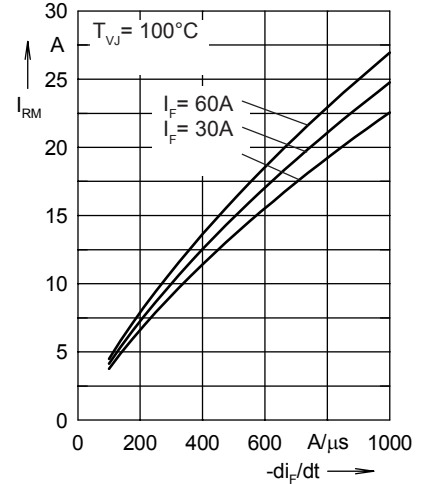

Fig. 19. Peak reverse current I_{RM}

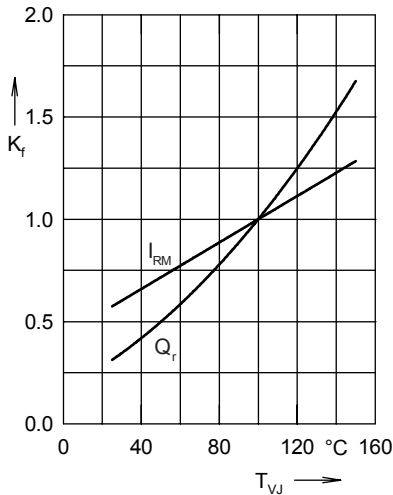

Fig. 20. Dynamic parameters Q_r , I_{RM}

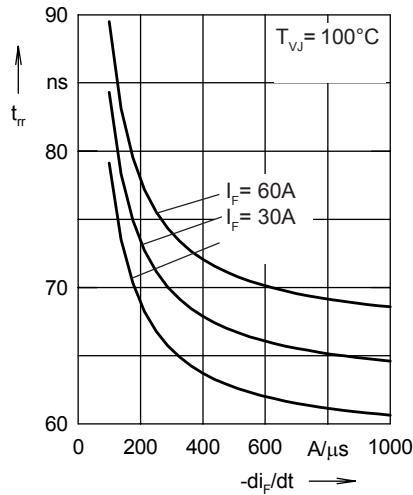

Fig. 21. Recovery time t_{rr} versus

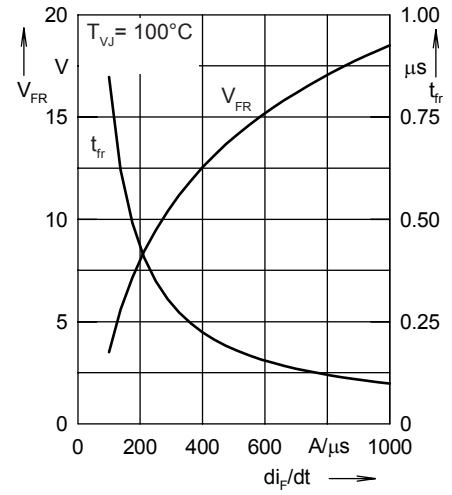

Fig. 22. Peak forward voltage V_{FR}

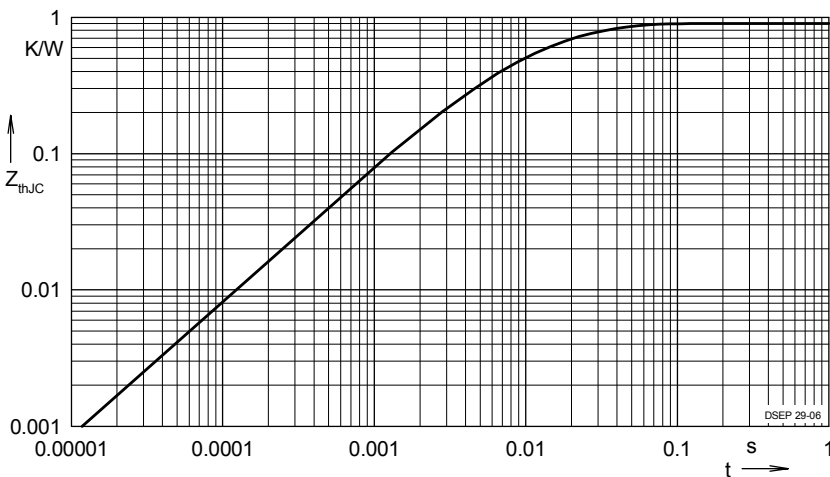

Fig. 23. Transient thermal resistance junction to case

Constants for Z_{thJC} calculation:

i	R_{thi} (K/W)	t_i (s)
1	0.502	0.0052
2	0.193	0.0003